



Installation manual

Rechargeable lead-acid battery 1,2Ah/12V

ZS-1.2



The rechargeable batteries are lead-lead dioxide systems. The dilute sulfuric acid electrolyte is absorbed by separators and plates and thus immobilized. Should the battery be accidentally overcharged producing hydrogen and oxygen, special one-way valves allow the gases to escape thus avoiding excessive pressure build-up. Otherwise, the battery is completely sealed and is, therefore, maintenance-free, leak proof and usable in any position.

Battery Construction

Component	Positive plate	Negative plate	Container	Cover	Safety valve	Terminal	Separator	Electrolyte
Raw material	Lead dioxide	Lead	ABS	ABS	Rubber	Copper/Pug	Fiberglass	Sulfuric acid

General Features

- Absorbent Glass Mat (AGM) technology for efficient gas recombination of up to 99% and freedom from electrolyte maintenance or water adding.
- Not restricted for air transport-complies with IATA/ICAO Special Provision A67.
- UL-recognized component.
- Can be mounted in any orientation.
- Computer designed lead, calcium tin alloy grid for high power density.
- Long service life, float or cyclic applications.
- Maintenance-free operation.
- Low self discharge.

Battery Specification

Nominal Voltage	12V
Number of cell	6
Design life	5 lat
Nominal Capacity 77°F (25°C)	
20 hour rate (0,06 A; 10,5 V)	1,2 Ah
10 hour rate (0,117 A; 10,5 V)	1,17 Ah
5 hour rate (0,23; 10,5 V)	1,15 Ah
1 hour rate (0,89 A; 9,6 V)	0,89 Ah
Internal Resistance	
Fully Charged battery 77°F (25°C)	≤90 mOhm
Self-Discharge	
3% of capacity declined per month at 20°C (average)	
Operating Temperature Range	
Discharge	-20°C—60°C
Charge	-10°C—60°C
Storage	-20°C—60°C
Max. Discharge Current 77°F (25°C)	18 A (5 s)
Short Circuit Current	60 A
Charge Methods: Constant Voltage Charge 77°F (25°C)	
Cycle use	2,30-2,35 VPC
Maximum charging current	0,48 A
Temperature compensation	-30 mV/°C
Standby use	2,23-2,27 VPC
Temperature compensation	-20 mV/°C

Dimensions and Weight

Length (mm / inch)	97 / 3,82
Width (mm / inch)	43 / 1,69
Height (mm / inch)	52 / 2,05
Total Height (mm / inch)	58 / 2,28
Approx. Weight (Kg / lbs)	0,56 / 1,23
* Weight deviation: ± 5%	

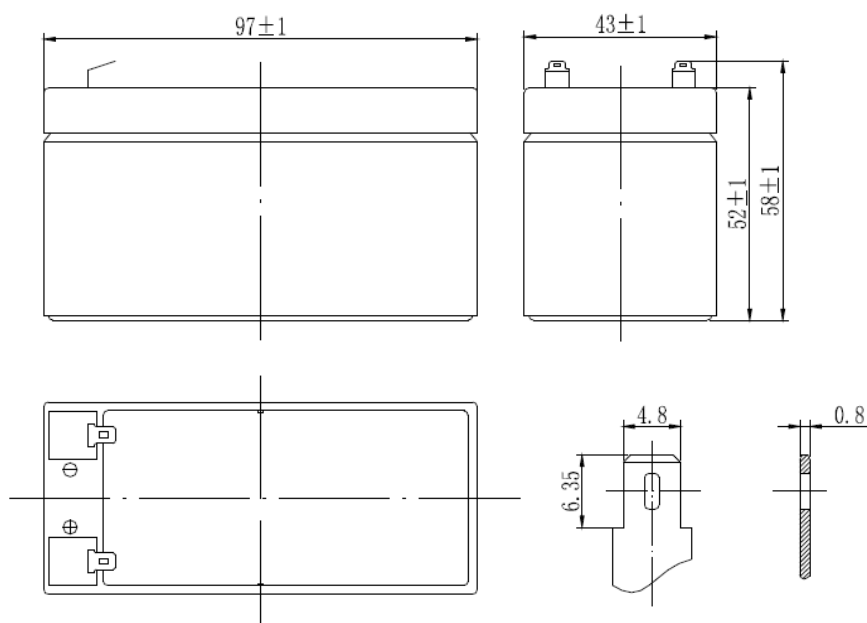

Discharge Constant Current (Amperes at 77°F (25°C))

End Point Volts/Cell	5 min	10 min	15 min	30 min	1 h	3 h	5 h	10 h	20h
1,60 V	5,72	3,85	2,67	1,49	0,89	0,39	0,25	0,129	0,065
1,65 V	5,42	3,66	2,55	1,43	0,86	0,37	0,24	0,125	0,064
1,70 V	5,12	3,48	2,43	1,36	0,83	0,36	0,24	0,120	0,064
1,75 V	4,80	3,28	2,31	1,30	0,79	0,34	0,23	0,117	0,060
1,80 V	4,48	3,08	2,18	1,23	0,76	0,33	0,22	0,115	0,060

Discharge Constant Power (Watts at 77°F (25°C))

End Point Volts/Cell	5min	10 min	15 min	30 min	45 min	1 h	2 h	3 h	5h
1,60 V	9,90	6,24	5,14	2,94	1,79	0,73	0,50	0,257	0,130
1,65 V	9,28	5,87	4,85	2,78	1,72	0,72	0,49	0,253	0,127
1,70 V	8,67	5,51	4,58	2,64	1,64	0,69	0,48	0,249	0,124
1,75 V	8,06	5,15	4,29	2,49	1,56	0,67	0,47	0,245	0,121
1,80 V	7,47	4,79	4,00	2,33	1,47	0,66	0,46	0,240	0,113

Note! The above characteristics data are average values obtained within threecharge / discharge cycles. All data shall be changed without notice, AAT SYSTEMY BEZPIECZEŃSTWA sp. z o.o. reserves the right to explain and updated the information.

Discharge Characteristics Curve (25°C)

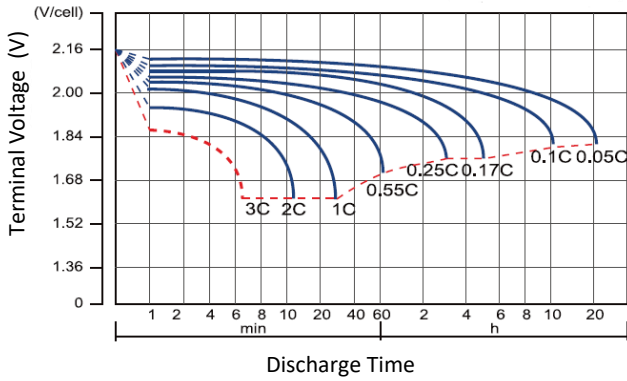

Charge Characteristic Curve For Standby Use (25°C)

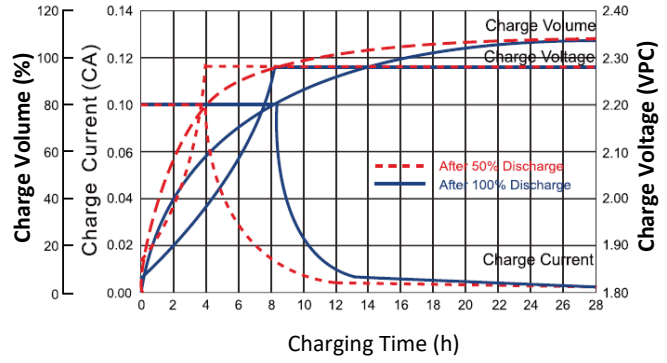

Relationship Between Charging Voltage And Temperature

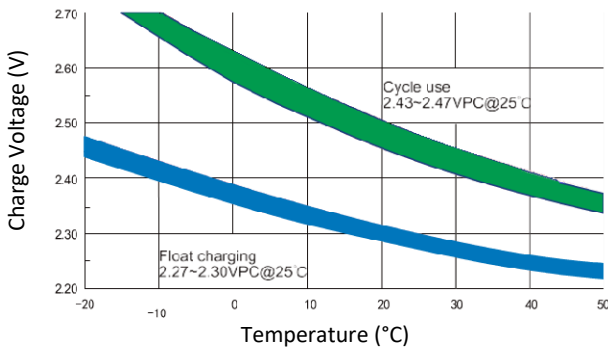

Storage Characteristics

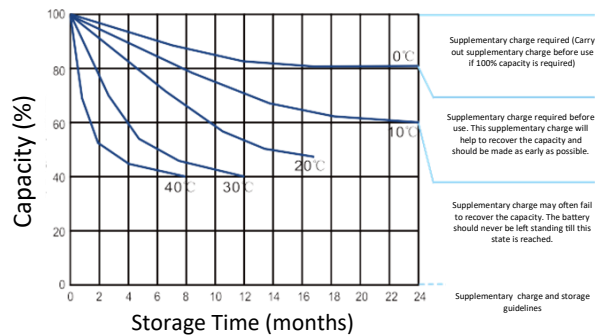

Life Characteristics Of Standby Use

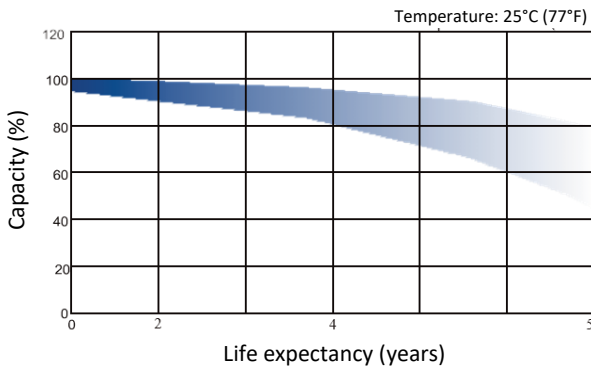

Cycle Life in Relation To Depth Of Discharge

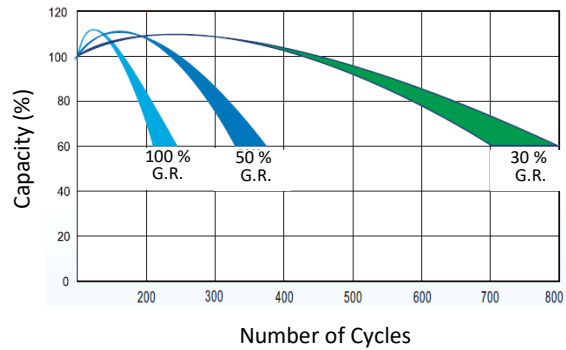

Effect Of Temperature On Long Term Life

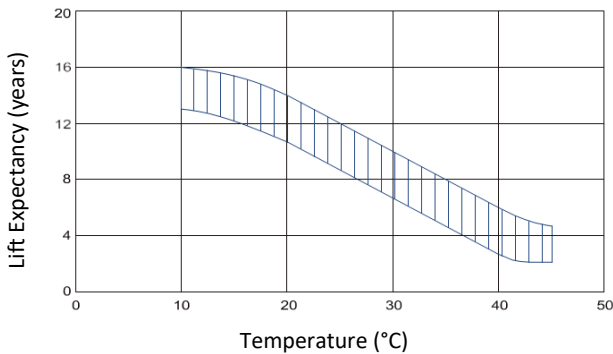

Temperature Effects On Capacity

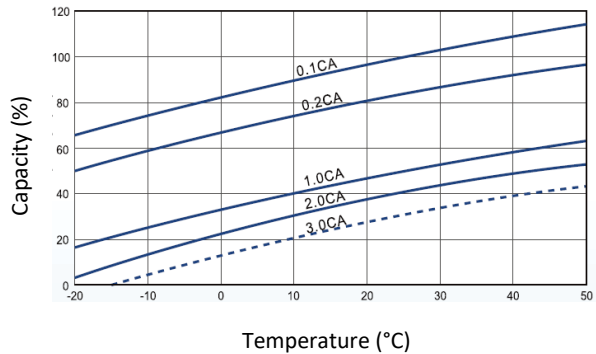

Notes

AAT SYSTEMY BEZPIECZEŃSTWA Sp. z o.o.



ul. Puławska 431, 02-801 Warszawa
tel. 22 546 05 46, faks 22 546 05 01
e-mail: aat.warszawa@aat.pl, www.aat.pl

Warszawa

ul. Koniczynowa 2a, 03-612 Warszawa
tel./faks 22 811 13 50, 22 743 10 11
e-mail: aat.warszawa-praga@aat.pl, www.aat.pl

Warszawa II

Antoniuk Fabryczny 22, 15-741 Białystok
tel./faks 85 688 32 33, 85 688 32 34
e-mail: aat.bialystok@aat.pl, www.aat.pl

Białystok

Fordońska 183, 85-737 Bydgoszcz
tel./faks 52 342 91 24, 52 342 98 82
e-mail: aat.bydgoszcz@aat.pl, www.aat.pl

Bydgoszcz

ul. Ks. W. Siwka 17, 40-318 Katowice
tel./faks 32 351 48 30, 32 256 60 34
e-mail: aat.katowice@aat.pl, www.aat.pl

Katowice

ul. Prosta 25, 25-371 Kielce
tel./faks 41 361 16 32, 41 361 16 33
e-mail: aat.kielce@aat.pl, www.aat.pl

Kielce

ul. Biskupińska 14, 30-737 Kraków
tel./faks 12 266 87 95, 12 266 87 97
e-mail: aat.krakow@aat.pl, www.aat.pl

Kraków

90-019 Łódź, ul. Dowborczyków 25
tel./faks 42 674 25 33, 42 674 25 48
e-mail: aat.lodz@aat.pl, www.aat.pl

Łódź

ul. Raclawicka 82, 60-302 Poznań
tel./faks 61 662 06 60, 61 662 06 61
e-mail: aat.poznan@aat.pl, www.aat.pl

Poznań

Al. Niepodległości 606/610, 81-855 Sopot
tel./faks 58 551 22 63, 58 551 67 52
e-mail: aat.sopot@aat.pl, www.aat.pl

Sopot

ul. Zielona 42, 71-013 Szczecin
tel./faks 91 483 38 59, 91 489 47 24
e-mail: aat.szczecin@aat.pl, www.aat.pl

Szczecin

ul. Na Niskich Łąkach 26, 50-422 Wrocław
tel./faks 71 348 20 61, 71 348 42 36
e-mail: aat.wroclaw@aat.pl, www.aat.pl

Wrocław

NIP: 9512500868, REGON: 385953687

Wpisana do rejestru przedsiębiorców prowadzonego przez Sąd Rejonowy dla m.st. Warszawy w Warszawie,
XIII Wydział Gospodarczy Krajowego Rejestru Sądowego pod numerem KRS 0000838329,
kapitał zakładowy wpłacony w całości w wysokości: 17 005 000,00 zł